



# RED SWASTIKA SCHOOL

## 2022 END OF YEAR EXAMINATION

### MATHEMATICS

Name : \_\_\_\_\_ (     )

Class : Primary 4 / \_\_\_\_\_

Date : 28 OCT 2022

### BOOKLET A

20 Questions

40 Marks

Duration of Paper : 1 hour 45 minutes

**Note:**

1. Do not open this Booklet until you are told to do so.
2. Read carefully the instructions given at the beginning of each part of the Booklet.
3. Do not waste time. If a question is difficult for you, go on to the next one.
4. Check your answers thoroughly and make sure you attempt every question.
5. In this booklet, you should have the following:
  - (a) Page 1 to Page 8
  - (b) Questions 1 to 20

Questions 1 to 20 carry 2 marks each. For each question, four options are given. One of them is the correct answer. Make your choice (1, 2, 3 or 4). Shade the correct oval (1, 2, 3 or 4) on the Optical Answer Sheet.

(40 marks)

---

- 1 The value of the digit 6 in 86 297 is \_\_\_\_\_.
- (1) 60
  - (2) 600
  - (3) 6000
  - (4) 60 000
- 2 Which of the following numbers below when rounded to the nearest ten becomes 74 500?
- (1) 74 444
  - (2) 74 498
  - (3) 74 509
  - (4) 74 552
- 3 How many one-fifths are there in 3 wholes?
- (1)  $1\frac{2}{3}$
  - (2)  $\frac{3}{5}$
  - (3) 5
  - (4) 15

4 Which of the following fractions is in its simplest form?

(1)  $\frac{5}{8}$

(2)  $\frac{2}{6}$

(3)  $\frac{3}{9}$

(4)  $\frac{6}{10}$

5 Which of the following decimals is represented by letter A in the number line?

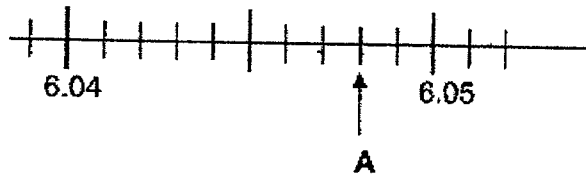

(1) 6.043

(2) 6.048

(3) 6.052

(4) 6.057

- 6 In the figure, which angle is a right angle?

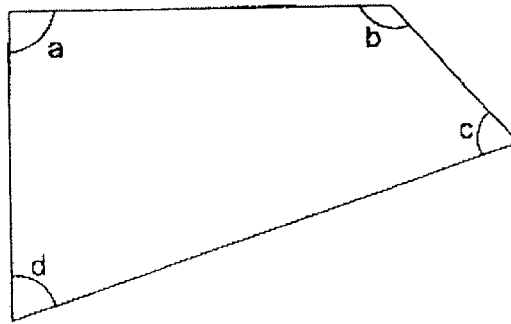

- (1)  $\angle a$   
 (2)  $\angle b$   
 (3)  $\angle c$   
 (4)  $\angle d$
- 7 7 is not a factor of \_\_\_\_\_.
- (1) 14  
 (2) 35  
 (3) 49  
 (4) 72

- 8 The table below shows the duration of 4 animal shows at a theatre in the zoo.

Show	Duration of show
Animal Friends	50 min
Rainforest Fights Back	55 min
Safari Hunter	1 h 10 min
The World of Pets	1 h 15 min

Janice watched one of the shows which started at 11 50 and ended at 13 05. Which show did she watch?

- (1) Animal Friends  
 (2) Rainforest Fights Back  
 (3) Safari Hunter  
 (4) The World of Pets

- 9 Mr Faiz had some stickers. He gave away  $\frac{2}{3}$  of his stickers to 5 students and had 30 stickers left. How many stickers did each of his students receive?

- (1) 18  
 (2) 12  
 (3) 9  
 (4) 4

- 10 The table below shows the number of books borrowed by some students.

Number of books borrowed	0	1	2	3
Number of students	2	1	4	2

How many students borrow at least 2 books?

- (1) 6  
 (2) 7  
 (3) 8  
 (4) 9

- 11 Tom is standing at point A and he is facing the library.

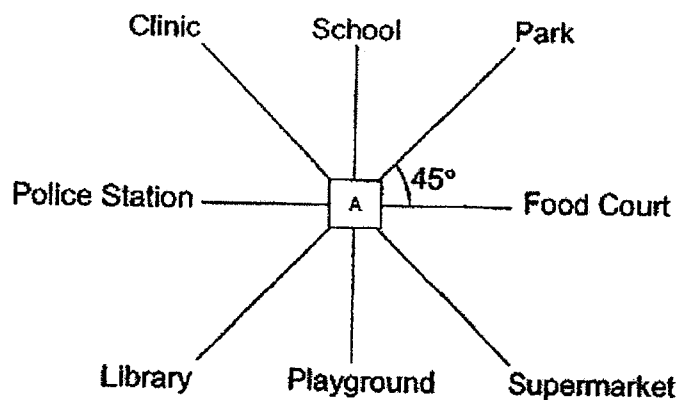

Tom turns through an angle of  $135^\circ$  in an anti-clockwise direction. Then, he makes a  $\frac{1}{4}$ -turn in a clockwise direction. Where will he be facing in the end?

- (1) Food Court  
 (2) Police Station  
 (3) Playground  
 (4) School

- 12 The figure below is made up of a rectangle R and a square S. The breadth of rectangle R is 14 cm.

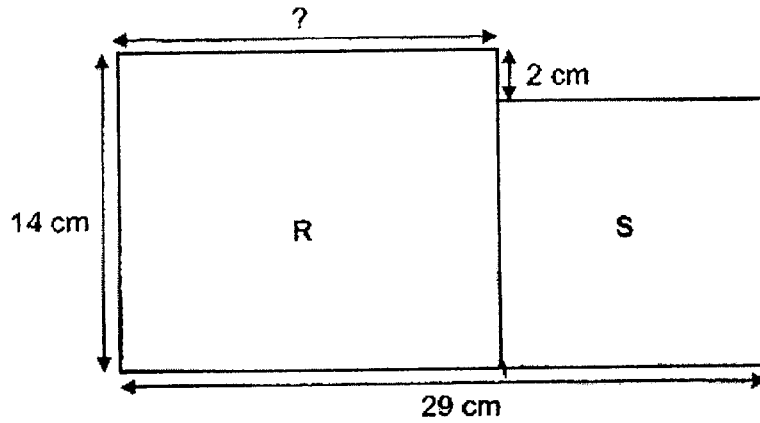

Find the length of rectangle R.

- (1) 12 cm
- (2) 13 cm
- (3) 15 cm
- (4) 17 cm

- 13 The figure below is made up of 2 rectangles.

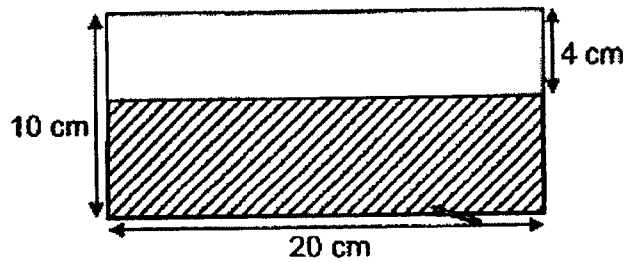

Find the area of the shaded rectangle.

- (1) 40 cm<sup>2</sup>
- (2) 80 cm<sup>2</sup>
- (3) 120 cm<sup>2</sup>
- (4) 200 cm<sup>2</sup>

14 Shamita is 1.5 m tall. She is taller than Ali by 0.03 m. How tall is Ali?

- (1) 1.20 m
- (2) 1.47 m
- (3) 1.53 m
- (4) 1.80 m

15 Miss Kim placed two identical boxes labelled A on the balance as shown. Find the mass of one of the boxes.

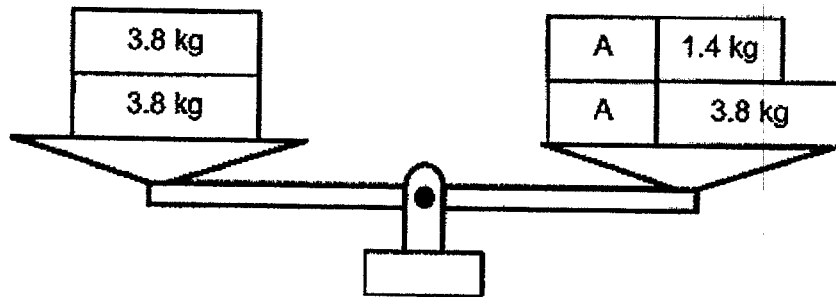

- (1) 1.2 kg
- (2) 2.4 kg
- (3) 5.2 kg
- (4) 7.6 kg

16 The information below shows the ingredients needed to make 2 jars of strawberry jam.

<b>Ingredients needed to make 2 jars of strawberry jam</b>
1.4 kg of strawberries
0.3 kg of sugar
2 lemons

Mrs Singh wanted to make 4 jars of strawberry jam. What is the least amount of strawberries she needs to buy?

- (1) 5 kg
- (2) 2 kg
- (3) 3 kg
- (4) 4 kg

- 17 The clock below is 10 minutes faster.

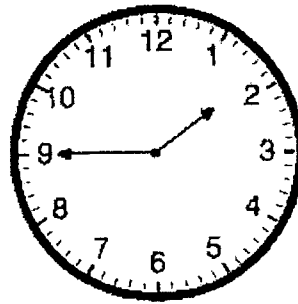

What is the actual time?

- (1) 13 35
- (2) 13 55
- (3) 14 35
- (4) 14 55

- 18 How many symmetric figure(s) is/are there below?

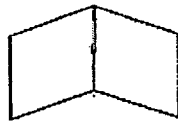

Figure A



Figure B

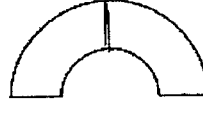

Figure C

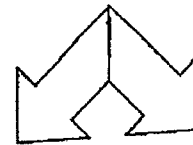

Figure D

- (1) 1
- (2) 2
- (3) 3
- (4) 4

- 19 A repeated pattern is formed using the letters A, B, C and D. The first 12 letters are shown below.

A B C D A B C D A B C D  
 1<sup>st</sup> 12<sup>th</sup>

How many 'A's are there if there is a total of 42 letters in the pattern?

- (1) 10
- (2) 11
- (3) 12
- (4) 13



- 20 The picture below shows part of the seating plan of a classroom.

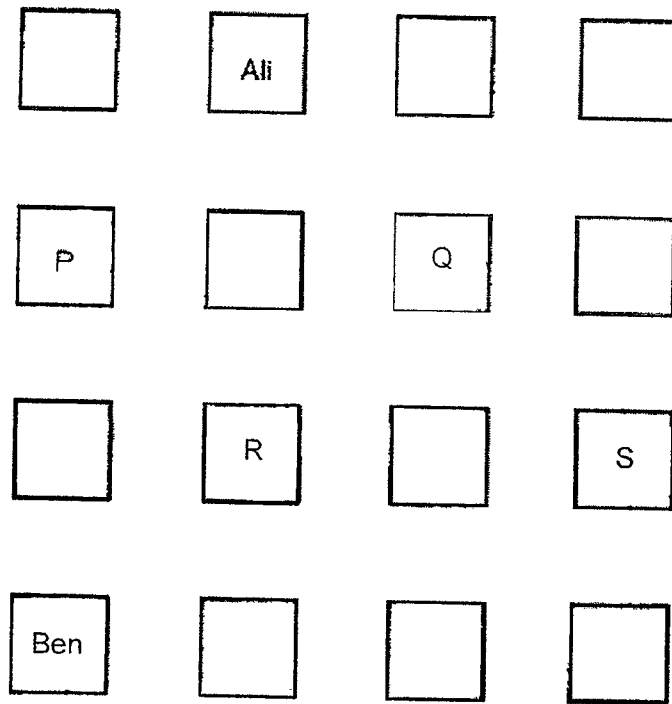

Ali is seated north-west of Claire while Claire is seated north-east of Ben.  
Which letter represents Claire's seat?

- (1) P  
(2) Q  
(3) R  
(4) S





**RED SWASTIKA SCHOOL**  
**2022 END OF YEAR EXAMINATION**  
**MATHEMATICS**

Name : \_\_\_\_\_ ( )

Class : Primary 4 / \_\_\_\_\_

Date : 28 OCT 2022

**BOOKLET B**

25 Questions  
 60 Marks

In this booklet, you should have the following:

- (a) Page 9 to Page 21  
 (b) Questions 21 to 45

**MARKS**

	OBTAINED	POSSIBLE
BOOKLET A		40
BOOKLET B		60
TOTAL		100

Parent's Signature : \_\_\_\_\_

Questions 21 to 40 carry 2 marks each. Show your working clearly in the space below each question and write your answers in the spaces provided. For questions which require units, give your answers in the units stated.

(40 marks)

---

21 What number is 100 more than 9997?

Ans: \_\_\_\_\_

---

22 Find the product of 3028 and 4.

Ans: \_\_\_\_\_

---

23 What is the remainder when 5093 is divided by 9?

Ans: \_\_\_\_\_

---

9

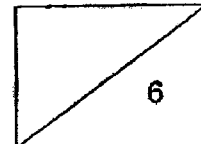

- 24 Write  $2\frac{1}{9}$  as an improper fraction.

Ans: \_\_\_\_\_

- 25 Find the value of  $1 - \frac{1}{8} - \frac{1}{4}$ .

Ans: \_\_\_\_\_

- 26 In the figure, PQRS is a rectangle. Find  $\angle x$ .

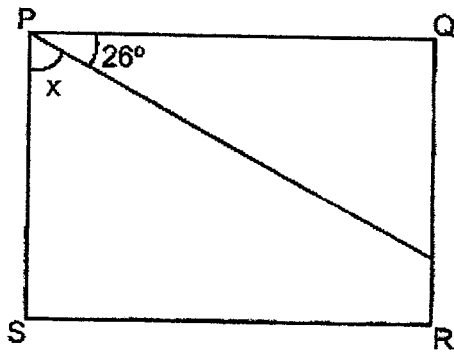

Ans: \_\_\_\_\_°

10

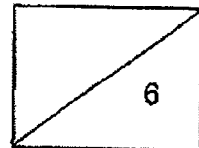

- 27 Write 8 thousandths as a decimal.

Ans: \_\_\_\_\_

28  $8.64 - 3.95 =$  \_\_\_\_\_

Ans: \_\_\_\_\_

- 29 Arrange the following numbers from the smallest to the greatest.

$$\frac{4}{5}, 0.804, 0.084$$

Ans: \_\_\_\_\_  
(smallest)  (greatest)

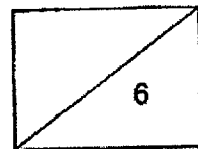

- 30 The perimeter of a square is 36 cm. What is its length?

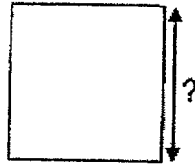

Ans: \_\_\_\_\_ cm

- 
- 31 Mrs Lee has some buttons. The number of buttons she has is more than 10 but fewer than 25. She can pack all the buttons into bags of 2 or 3 with no remainder. What is one possible number of buttons she has?

Ans: \_\_\_\_\_

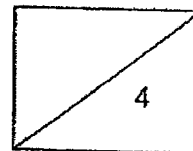

The line graph below shows the number of visitors to the zoo in six months. Study the graph and use it to answer Questions 32 to 34.

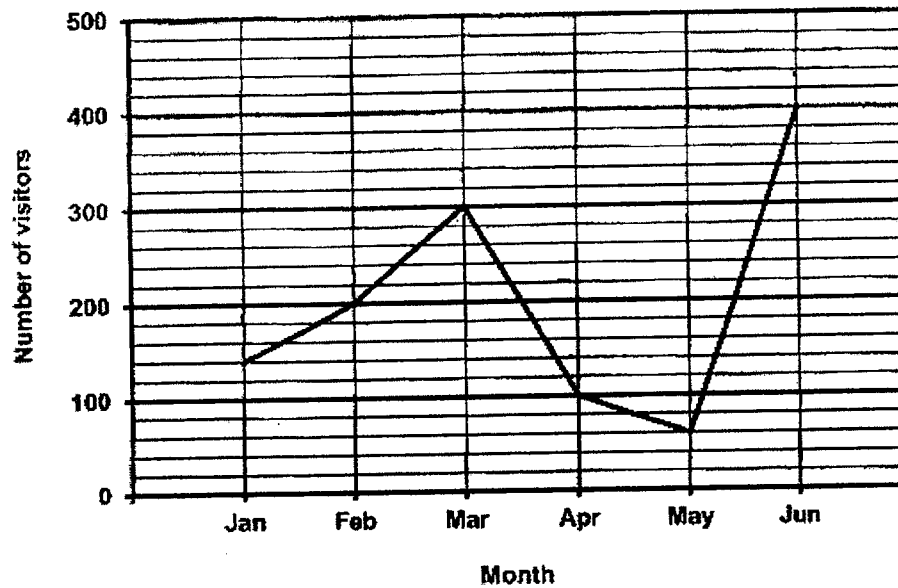

- 32 How many visitors visited the zoo from January to March?

Ans: \_\_\_\_\_

- 33 Which one-month period shows the greatest decrease in the number of visitors?

Ans: \_\_\_\_\_ to \_\_\_\_\_

- 34 In which month was there half as many visitors as the month of June?

Ans: \_\_\_\_\_

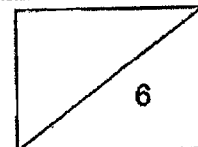



35 The table below shows part of the menu at a cafe.

Item	Small	Medium	Large
Drink	\$0.80	\$1.20	\$1.70
Fried rice	\$1.50	\$1.80	\$2.50
Spaghetti	\$2.00	\$2.60	\$3.50

Mr Gan bought a drink, 1 small fried rice and 1 medium spaghetti. The total cost of all his items was \$5.30. What was the size (small, medium or large) of the drink he bought?

Ans: \_\_\_\_\_

36 Peili drew five lines as shown below.

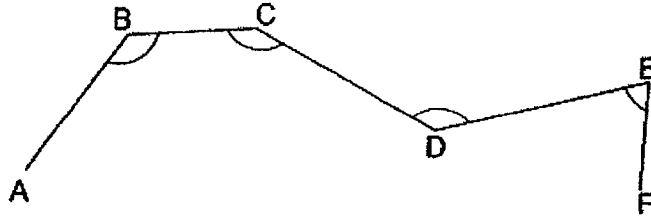

(a) Measure and write down the size of  $\angle ABC$ .

(b) Name an angle that is smaller than  $\angle ABC$ .

Ans: (a) \_\_\_\_\_<sup>o</sup>

(b)  $\angle$  \_\_\_\_\_

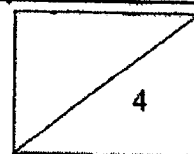

- 37 Rani needed 30 minutes to bake a cake. At 12.45 p.m., she had baked 3 such cakes. At what time did she start baking the first cake given that she baked one cake after another, without any break in between? Express your answer using the 12-hr clock.

Ans: \_\_\_\_\_

- 38 Complete the symmetric figure below with XY as the line of symmetry.

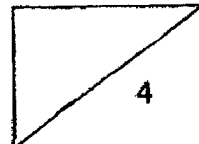
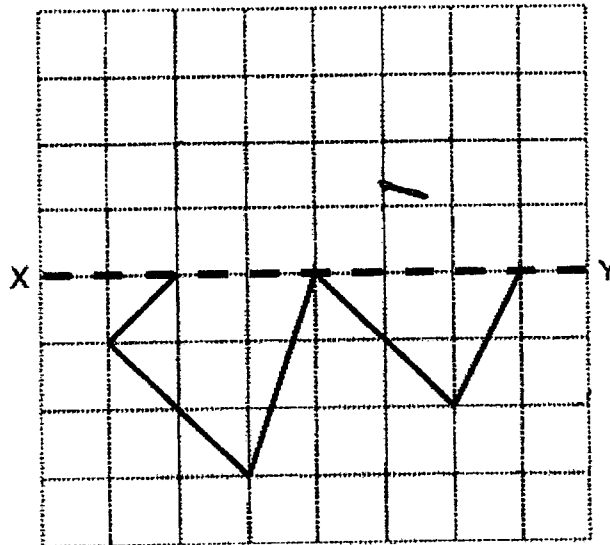

- 39 Figure 1 is a rectangle with length AB. Figure 2 is made up of four such rectangles. The perimeter of Figure 2 is 240 cm. Find the length of AB.

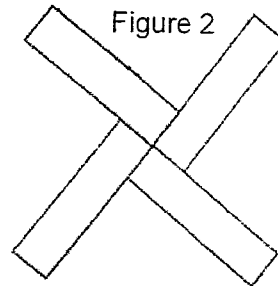
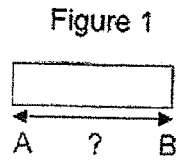

Ans: \_\_\_\_\_ cm

- 40 Sarah and James went shopping together. Sarah wanted to buy a book but she was short of \$15.60. James also wanted to buy the same book but he was short of \$8.40.

Each statement below is either true, false or not possible to tell from the information given above.

For each statement, put a tick (✓) in the correct column.

Statement	True	False	Not possible to tell
(a) Sarah had \$7.20 more than James.			
(b) The book cost less than \$10.			

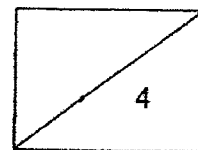

Questions 41 to 45 carry 4 marks each. Show your working clearly in the space below each question and write your answers in the spaces provided.

(20 marks)

---

41 Alice, Bala and Carin shared 850 cards. Bala had 30 more cards than Alice. Carin had 40 more cards than Bala.

(a) Who had the most number of cards?

(b) How many cards did Bala have?

Ans: (a) \_\_\_\_\_ [1]

(b) \_\_\_\_\_ [3]

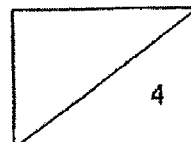

42 Mr Kumar mixed 15 l of blue paint and 15.42 l of red paint to obtain purple paint. He then poured all the purple paint into a big container and a small container. The amount of paint poured into the big container was 5 times as much as that in the small container.

- (a) How much purple paint did Mr Kumar have?
- (b) How much purple paint did Mr Kumar pour into the small container?

Ans: (a) \_\_\_\_\_ [2]

(b) \_\_\_\_\_ [2]

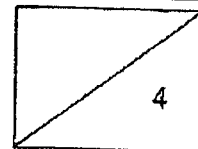

- 43 At first, all the donuts in a bakery were placed on 20 trays with an equal number of donuts on each tray. 5 trays were removed and the donuts on these trays were distributed equally on the remaining 15 trays. In the end, the number of donuts on each remaining tray increased by 2.
- (a) Find the total number of donuts on the 5 trays which were removed.
- (b) Find the number of donuts on each tray at first.

Ans: (a) \_\_\_\_\_ [2]

(b) \_\_\_\_\_ [2]

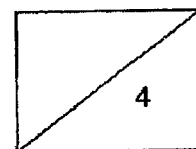

- 44 Nurul had 280 red and blue marbles altogether. After Nurul gave away  $\frac{1}{3}$  of her red marbles, the number of red marbles left was equal to the number of blue marbles she had.
- (a) What fraction of her red marbles had Nurul left?
- (b) Find the difference in the number of red and blue marbles Nurul had at first.

Ans: (a) \_\_\_\_\_ [2]

(b) \_\_\_\_\_ [2]

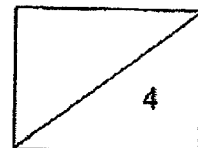

- 45 The figure PQRS is formed by two different squares and two identical rectangles. The area of the big square is  $25 \text{ cm}^2$  and the area of the small square is  $9 \text{ cm}^2$ .

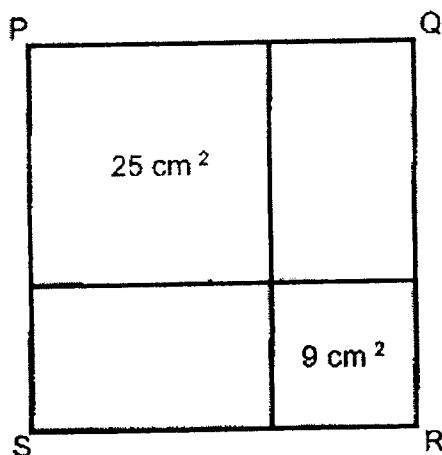

- (a) Find the area of one rectangle.

Ans: (a) \_\_\_\_\_ [3]

- (b) Circle the words that describe PQRS correctly in the following statement.

PQ is ( shorter than / as long as / longer than ) QR  
and PQRS ( is / is not ) a square.

[1]

End of Paper

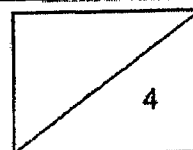



SCHOOL : RED SWASTIKA PRIMARY SCHOOL  
 LEVEL : PRIMARY 4  
 SUBJECT : MATHEMATICS  
 TERM : 2022 SA2

PAPER 1 BOOKLET A

Q 1	Q2	Q3	Q4	Q5	Q6	Q7	Q8	Q9	Q10
3	2	4	1	2	1	4	4	2	1
Q 11	Q12	Q13	Q14	Q15	Q16	Q17	Q18	Q19	Q20
3	4	3	2	1	3	1	3	2	2

PAPER 1 BOOKLET B

Q21)	10097
Q22)	12112
Q23)	8
Q24)	$\frac{19}{9}$
Q25)	$\frac{5}{8}$
Q26)	$64^\circ$
Q27)	0.008
Q28)	4.69
Q29)	$0.084$ , $\frac{4}{5}$ , $0.804$
Q30)	$36 \div 4 = 9\text{cm}$
Q31)	12
Q32)	$200 + 300 = 500$ $500 + 140 = 640$
Q33)	March to April
Q34)	$400 \div 2 = 200$ Ans: February
Q35)	$1.50 + 2.60 = 4.10$ $5.30 - 4.10 = 1.20$ Ans: Medium
Q36)	a) $130^\circ$ b) $< FED$

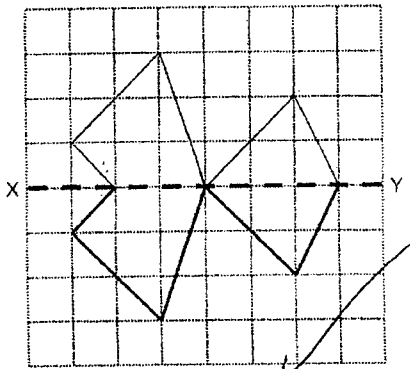
Q37)	11.15a.m.
Q38)	
Q39)	$240 \div 4 = 60$ $60 \div 2 = 30\text{cm}$
Q40)	a) False b) False
Q41)	a) Carin b) $30 + 30 = 60$ $60 + 40 = 100$ $850 - 100 = 750$ $750 \div 3 = 250$ $250 + 30 = 280$
Q42)	a) $15.42 + 15 = 30.42\ell$ b) $5 + 1 = 6$ $30.42 \div 6 = 5.07\ell$
Q43)	a) $20 - 5 = 15$ $15 \times 2 = 30$ b) $30 \div 5 = 6$
Q44)	a) $\frac{3}{3} - \frac{1}{3} = \frac{2}{3}$ b) $1 + 2 + 2 = 5$ $280 \div 5 = 56$
Q45)	a) $15\text{cm}^2$ b) PQ is (shorter than / <u>as long as</u> / longer than) QR and PQRS ( <u>is</u> / is not ) a square.